

ASSEMBLY INSTRUCTIONS

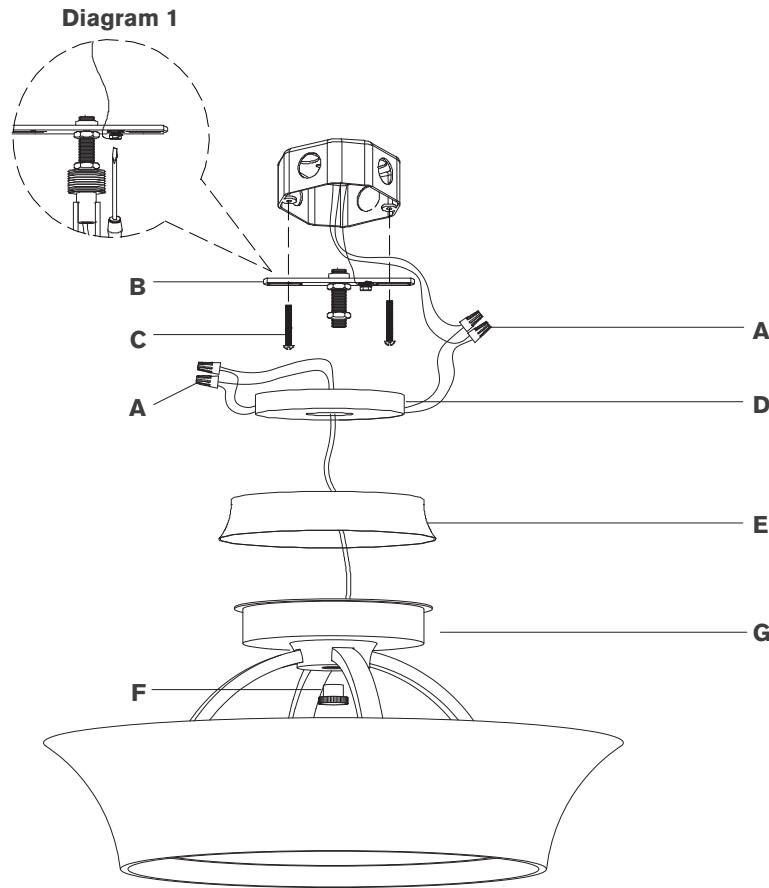

Garland 15" Dual Lit Ring Semi-Flush Mount

Item # TOB4520

NOTICE:

This light fixture should be installed in accordance with all applicable, local installation codes, and by a person familiar with the construction and operation of it, as well as the hazards involved. Inspect item and contents carefully. If any damage or defect is found, do not install. Retain all packaging material until installation is complete and approved.

TOOLS REQUIRED (NOT INCLUDED):

Phillips Screwdriver

Slotted Screwdriver

1. Carefully remove all parts from the box. Place on a clean, soft surface.
2. Remove threaded cap (F) from mounting plate (B).
3. Install mounting plate (B) to junction box and secure with mounting screws (C).
4. Connect supply ground wire (usually green or bare copper) around the green grounding screw (see diagram 1). Tighten.
NOTE: It is imperative that the fixture is grounded
5. Feed wires through canopy cover (E) and driver (D).
6. Connect fixture neutral wire (black) to the driver output neutral wire (black) using wire nut (A).
7. Connect fixture hot wire (red) to the driver output hot wire (red) using wire nut (A).
8. Connect driver input neutral wire (white) to the supply neutral wire (usually white) using wire nut (A).
9. Connect driver input hot wire (black) to the supply hot wire (usually black) using wire nut (A).
CAUTION: Do not reverse the hot and neutral connections.
10. Make sure all wire connections are tight, then carefully tuck into the junction box.
11. Install driver (D), canopy cover (E) and fixture body (G) to mounting plate (B) and secure with threaded cap (F).

Care Instructions: Clean only with a soft dry cloth or feather duster. Do not use abrasive or chemical agents.